



**ARCHITYPE**  
more than stone

# Fabrication and installation





**ARCHITYPE**  
more than stone

05-555 Tarczyn, al. Krakowska 64, Grzędy

+48 22 602 20 22

info@architype.eu, architype.eu

## **Symbols**

The following symbols are used in this manual:



Important



Note

This guide supersedes all previous guides. The contents are subject to change at any time without notice. Caesarstone® is a registered trademark of Caesarstone Ltd.

The information and recommendations contained in this document are believed to be correct to the best of our knowledge at the time of publication. The information and data should not necessarily be considered complete and accurate under all circumstances.

The information and data presented in this document are intended for use by individuals with technical skills, and such usage is at their own discretion and risk. We assume no responsibility for any consequences that may arise from the manufacturing and installation of our products.

The suggestions contained in this document should not be confused or combined with a violation of applicable laws, regulations, directives, or insurance requirements. Any use of data and information must comply with all applicable laws and regulations.

There are no explicit or implied warranties of commercial benefit, fitness for a particular purpose, etc.



**ARCHITYPE**  
more than stone

# Fabrication and installation

Caesarstone University



# Table of Contents

<b>1. Introduction</b>	<b>4</b>
<b>2. Slab information</b>	<b>6</b>
2.1 Slab parameters	6
2.2 Slab stamp	6
2.3 Slab label	7
<b>3. Safety</b>	<b>8</b>
3.1 General safety procedures	8
3.2 Working in areas with harmful silica dust	9
<b>4. Handling, transportation, and storage</b>	<b>10</b>
4.1 Handling	10
4.1.1 Loading methods	10
4.2 Transportation	11
4.2.1 Driver duties	11
<b>5. Visual inspection of the slab</b>	<b>14</b>
5.1 Inspection process	14
5.2 Colour matching	14
<b>6. Tools and equipment</b>	<b>16</b>
6.1 Mandatory equipment	16
6.2 Additional equipment	16
6.3 Essential tools	16
6.4 Accessories	17
6.5 Bonding material	17
<b>7. Preparation for fabrication</b>	<b>18</b>
7.1 Planning	18
7.2 Measurement	18
7.2.1 Template measurement	18
7.2.2 Direct measurements	20
7.3 Efficient utilisation of the slab work surface	21
<b>8. Fabrication</b>	<b>22</b>
8.1 Cutting the slab	22
8.1.1 Straight line cutting	22
8.1.2 Curved line cutting	22
8.1.3 Cutting holes	22
8.2 Seam joints	23
8.3 Inner corners	23
8.4 Cut-outs	24
8.4.1 Method for creating cut-outs for accessories	25
8.5 Edge polishing	26
8.5.1 Polished finish	27
8.5.2 Matte finish	27
8.5.3 Textured/Viento finish	27



8.6	Edge fabrication	28
8.6.1	Single edges	28
8.6.2	Laminated edges	29
8.6.2.1	Miter edges at a 45° angle	30
8.6.2.2	Multilayered edges ("sandwich" underlayment)	32
8.6.2.3	L-shaped edges	33
8.7	Transportation of finished surfaces	34
<b>9. Installation</b>		<b>36</b>
9.1	Preparation of basic parts	36
9.2	Countertops	37
9.2.1	Preparation for installation	37
9.2.2	Seam joints	37
9.2.3	Surface connection to the wall	38
9.3	Sinks	38
9.4	Accessories and fastening elements	39
9.4.1	Mechanical attachment of accessories	39
9.4.2	Attachment of accessories using bonding materials	40
9.5	Overhangs	40
9.6	Work surface of the table	41
9.7	Finalising installation procedures	41
9.8	Demonstration label	41
<b>10. Care and maintenance</b>		<b>42</b>
10.1	Resistance to thermal impact	42
10.2	Resistant to mechanical damage	43
10.3	Matte, textured / Viento and Motivo finished products: care and maintenance	43
10.4	Difficult to remove or dried stains	43
10.4.1	Recommended stain removers	43
10.4.2	Stain treatment	44
<b>11. Environmental protection agreement</b>		<b>46</b>
<b>12. Technical characteristics</b>		<b>48</b>

# 1. Introduction





Caesarstone quartz surfaces are ideal for a wide variety of commercial and residential interior applications, including those that are subjected to heavy use. Common areas include kitchen work surfaces, bathrooms, bar tops, vanities, reception counters, flooring, wall panelling and furniture cladding.

Quartz surfaces should not be used outside enclosed spaces or in areas exposed to ultraviolet radiation or excessive heat.

Caesarstone quartz surfaces are manufactured in a wide range of colours and are divided into several series according to their unique properties.

Caesarstone surfaces contain up to 93% quartz (one of the hardest minerals) and high-quality polymer resins and pigments that are compressed under strong vibration, vacuum, and pressure to form non-porous, high-density slabs. The quartz surfaces are then finished to a certain thickness and polished.



## 2. Slab information

### 2.1 Slab parameters

The slab parameters below are nominal for storage and transportation. The actual suitable for operation surface is slightly smaller due to the bevelled perimeter.

#### Length

3050 mm +/- 10mm

#### Width

1440 mm +/- 5 mm

#### Thickness

13 mm; 20 mm; 30 mm +/- 1 mm

#### Weight

140 kg; 220 kg; 330 kg

 13mm slabs are available in some colours.

### 2.2 Slab stamp

An identification information is placed on the back of the slab. The information remains on the slab for its lifetime and can be used for identification after installation.

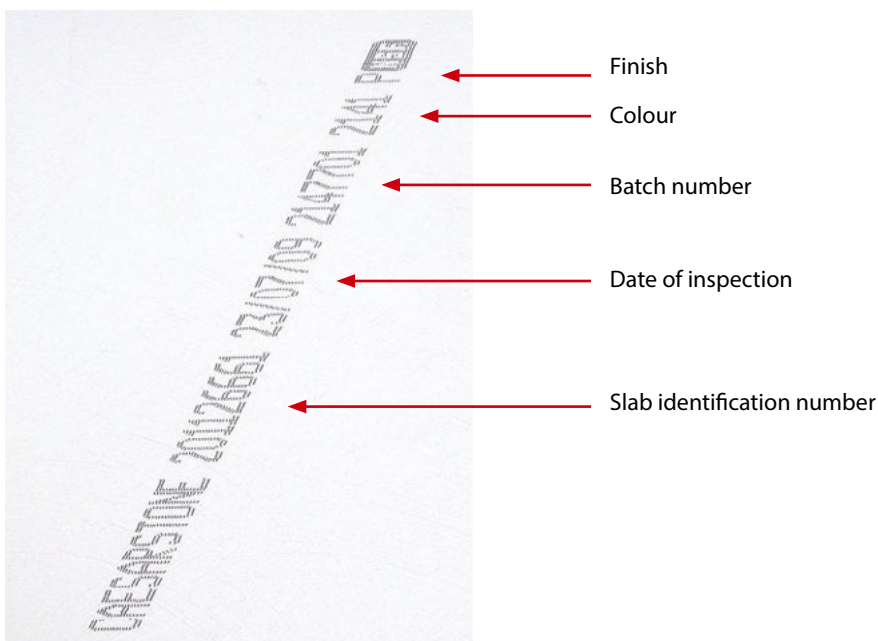

Detailed stamping information on the back of the slab





## 2.3 Slab label

Each slab manufactured by Caesarstone is individually inspected and quality controlled, after which the colour of its label is determined: yellow or green. The yellow and green labels contain the same information.

Green labels indicate slabs that may have been subjected to visual inspection. It is the responsibility of the manufacturer to ensure that any defect can be rectified and is not related to the finished product.

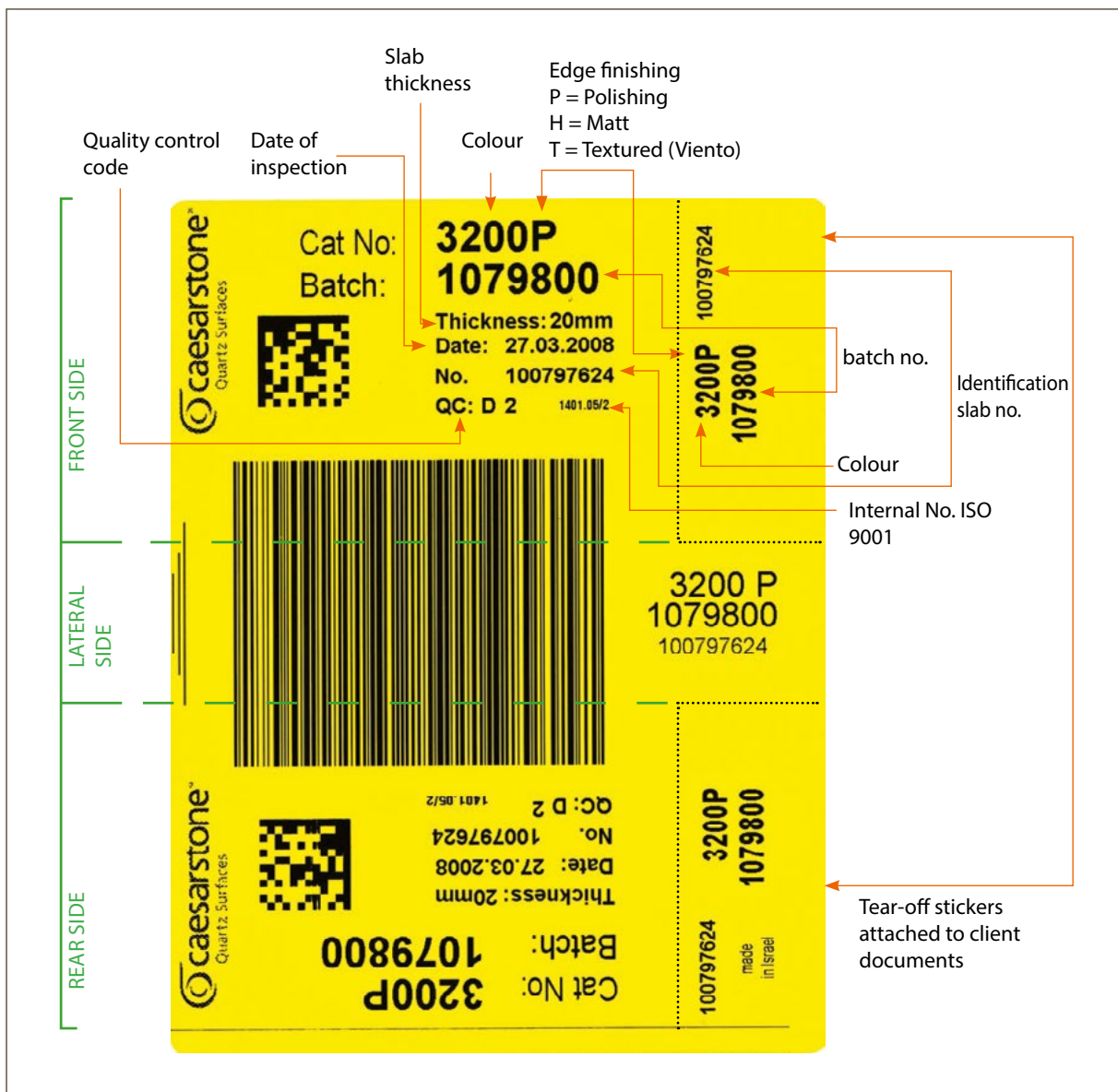

# 3. Safety

## 3.1 General safety procedures

Providing a safe working environment has always been highly important to Caesarstone. We require our distributors, manufacturers, and assemblers to adhere to the same level of safety and compliance with local occupational hygiene, safety, and health standards.

- Keep your work area clean, as clutter is often the cause of accidents.
- Make sure your work area is dry, well-ventilated, and well-lit.
- Do not overexert yourself. Always maintain correct posture and balance.
- Keep children and visitors at a safe distance from the work area.
- Always keep a fully equipped first aid kit on site.
- Read the manual with instructions on how to use the tools. Carefully study the application of the tools, notes on maintenance, limitations, and possible risks.
- Use suitable tools. Avoid using tools or appliances for functions they were not designed for. Do not use them at high speed. Do not work with non-standard tools.
- Keep the tools in good condition. Keep them sharp and clean to ensure high operational safety.
- All electrical tools must be fitted with a residual current device (RCD). Grounded plugs must be connected to grounded electrical outlets. If an adapter is used to connect to a two-prong socket, the adapter plug must be grounded. Never remove the third prong.
- If it is necessary to use clamps, vises, or other clamping devices, both hands should be used to clamp the parts.
- Always remove clamps and wrenches. Before switching on the device, check that the clamps and set wrenches have been removed.
- Never wear loose clothing, scarves, rings, bracelets, or other jewellery that could get caught in moving parts.
- Wear the following protective clothing while making quartz surfaces:
  - Coverage for long hair
  - Helmet (during handling and transporting)
  - Respirator
  - Non-slip safety shoes with steel coating
  - Earplugs while working in noisy areas
  - Safety goggles or other approved eye protection
  - Gloves for protection against chemicals and rough materials
  - In wet areas, in addition to the above, aprons and rubber boots.





## 3.2 Working in areas with harmful silica dust ⚠️

The distributor must provide its customers with full information regarding health and safety at work, especially when working in areas with silica dust.

Caesarstone surfaces and products supplied to the end user are not hazardous. However, they do contain crystalline silicon (quartz), so silica dust may be generated during handling (e.g. cutting, grinding, chopping, drilling, sanding, or milling) and waste processing.

Exposure to such dust is hazardous to health and can cause serious diseases such as, silicosis, lung cancer, fibrosis, tuberculosis, kidney disease, corneal damage, and skin and eye irritation.

Existing health problems can worsen by adverse effects of silica dust.

If you notice any of these symptoms, rinse the affected area thoroughly with plenty of water. If you have difficulty breathing, go out for fresh air. In case of any potential discomfort, it is advisable to consult with a doctor.

The manufacturing and processing of any products must always be carried out in accordance with the rules of the silica dust control programme and all applicable laws, regulations, orders, and directives. Also, when working, it is essential to consider the permissible exposure limits of quartz dust on the human body.

Health and Safety Organisation requirements can be found at [www.osha.gov](http://www.osha.gov), the International Labour Organization - [http://www.ilo.org/safework/info/lang-en/WCMS\\_i08566/index.htm](http://www.ilo.org/safework/info/lang-en/WCMS_i08566/index.htm) and the European Silica Dust Organisation - <http://www.nepsi.eu/good-practice-guide.aspx>.

In addition to any other applicable safety precautions, the following must be observed:

- Hang «Harmful Dust» signs in all areas where it is present.
- Wear a suitable mask while in any area where there is a «Harmful Dust» sign.
- Use a dust extraction system to remove dust from the production area. Ensure that the intake, filtration, and ejection systems are working properly.
- Use wet tools to reduce the amount of dust in the air.
- At the end of each shift, make sure your work area is thoroughly cleaned.
- At the production site, wear special work uniforms, including boots and socks. At the workplace, change into work clothes. Before leaving the workplace, shower and change into clean clothes. Wash clothes before using them again.
- Do not clean clothing, machinery or decking with compressed air. Clean only with a Hoover.
- Eating, drinking, and smoking are only allowed in designated areas that are free of harmful dust.
- You should wash your hands and face before drinking, eating, and smoking.
- Workers are required to undergo a medical examination in accordance with local regulations.



## 4. Handling, transportation, and storage

During all stages of handling, transportation, and storage, it is crucial to ensure that the slabs maintain balanced centre of gravity.

### 4.1 Handling

Caesarstone slabs should be loaded, unloaded, and moved by forklift, overhead crane, or other suitable lifting equipment (refer to overhead crane guidelines).

- A technical specialist, specializing in lifting and loading, must verify that all lifting equipment and devices are appropriate for the intended purpose and that the load weight adheres to the specified standards.
- When more than one slab is lifted at a time, it is necessary to stack them face to face or back to back.
- ⚠ During unloading and transport, strictly adhere to all necessary safety instructions regarding employees and equipment.
- The recommended equipment for securing slabs to the lifting device includes clamps or straps.



#### 4.1.1 Loading methods

- Lift slabs using one of the methods below.
- ⚠ When lifting slabs with a scissor lift or standard lifting clamp, start slowly, making sure the slabs are well secured beforehand.



Scissor lift



Lifting clamp (Clamp Lifter)



Lifting straps



## 4.2 Transportation

Caesarstone slabs being both large and heavy, require safe and proper transportation. They must be securely fastened to the lorry as shown below.

- Securely attach the appropriate frame to the lorry for loading Caesarstone slabs, e.g. an A-frame.
- Load the boards evenly on both sides of the frame, stacking them face to face or back to back.
- Tie the slabs to the frame.
- Secure the framed slabs to the lorry



### 4.2.1 Driver duties



Drivers must remain in their transport vehicles. Drivers must ensure that:

- The appropriate slabs have been loaded.
- The load is within the carrying capacity of the means of transport.
- The load was securely fastened to the vehicle before travelling.

# Handling, transportation, and storage

## 4.3 Storage

The illustration below shows the recommended method of storing slabs.

- Caesarstone recommends storing slabs in the shade (do not expose them to the direct sunlight) as far as possible.
  - Secure the slabs with two auxiliary supports spaced 1500-1800 mm apart, ensuring the slab is centered. The slab should be supported along its entire length.
  - The maximum allowable number of slabs in a storage cell is as follows:
    - 8 x 30 mm
    - 12 x 20 mm
    - 10 x 13 mm. Add two slabs between the batch and the support for reinforcement, and two more slabs on the outside for protection. Use 2 x 30 mm, or 1 x 20 mm slabs, preferably with a coarse fraction as they are less flexible.
  - When storing slabs in places exposed to sunlight and high temperatures, it is recommended to provide additional support to prevent deformation. This can be done by building a third support or by placing a 30mm slab close to the supports.
  - Store the edge slabs with the sides facing outwards so that the polished surface is not exposed to unfavourable conditions.
  - If there are several slabs in a set and they are exposed to strong winds, they should be reinforced. To prevent them from falling, place a wooden wedge at a 90 degree angle between the last slab in the set and the nearest support.
  - It is recommended to put wooden or plastic buffers to prevent splitting.
-  Caesarstone slabs are heavy and can cause serious injury or death if not stored and handled properly. To maintain workplace safety, it is recommended that all slabs be securely fastened during storage.
-  When storing slabs on a triangular frame, make sure they are securely positioned on the frame. Otherwise, uneven pressure can cause the frame to shift and slabs to fall.

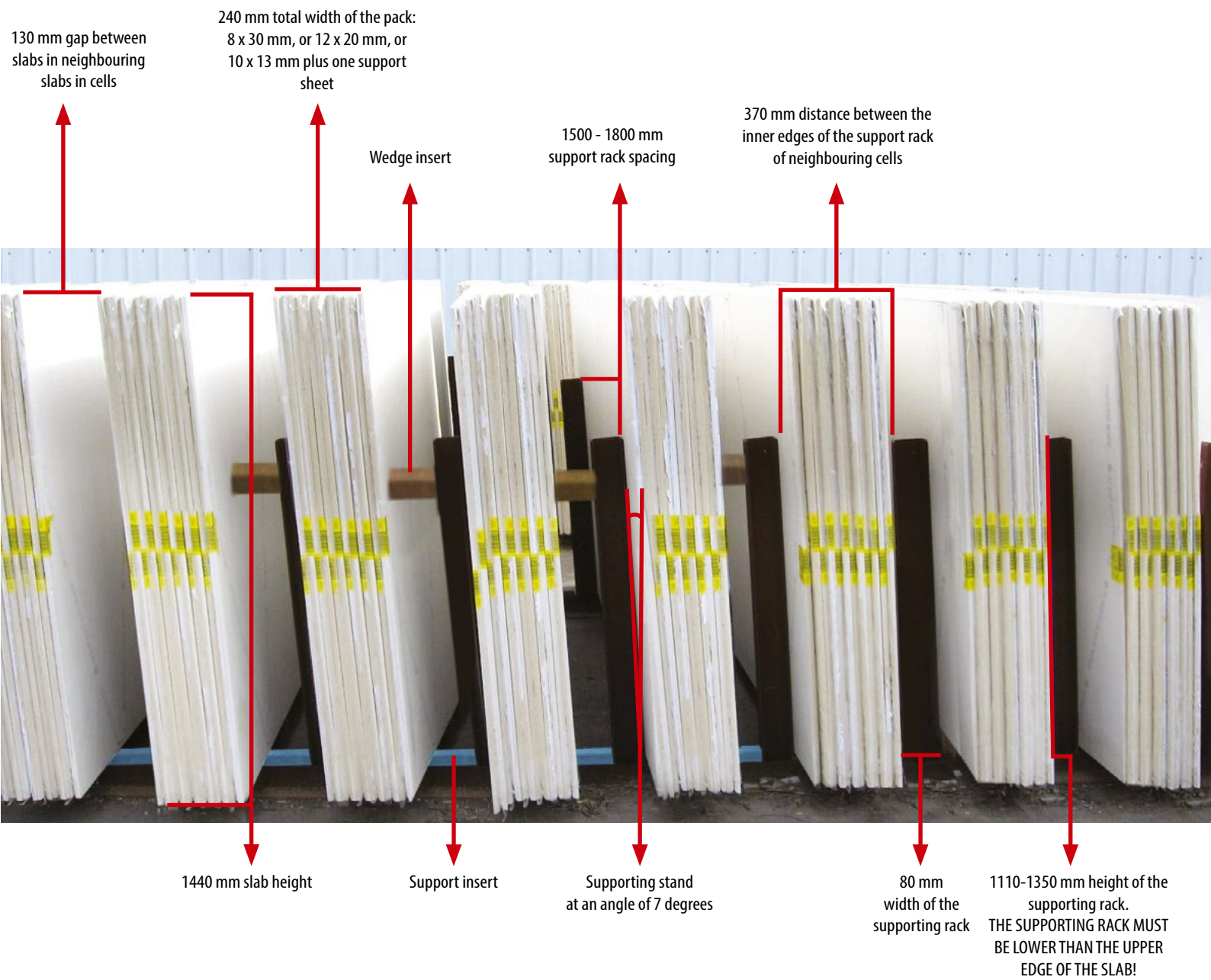

# 5. Visual inspection of the slab

## 5.1 Inspection process

Before cutting, the slab should be visually inspected for defects on the front and back, including the outer edge.

- Caesarstone covers all slabs with a transparent film. Remove it for visual inspection.
- Perform the following visual inspection for defects:
  - Chips, cracks, ripples, cavities, damage
  - Colour matching of sheet to sheet
  - Colour inconsistency within the same sheet
  - Unusual stains
  - Inconsistency with the quartz sample
  - Incompatible levels of polish
  - Thickness accuracy  $\pm 1$  mm
  - Deformation: 2 mm over the entire length and width when the slab is horizontal and fully supported.



- ⚠ Caesarstone will not accept any claim for any of the above if the slab is altered in any way. It is the responsibility of the manufacturer to determine the suitability of the slabs for use. Unsuitability of slabs must be assessed before the material is accepted for use.
- 🔍 The length of the deformation should be checked against a slab of the correct length in a horizontal position.

## 5.2 Colour matching

The slabs contain approximately 93% natural quartz. This may cause slight differences in colour between production cycles.

- Each production cycle has a specific batch number. This number is fixed on a label attached to each slab. It is also stamped on the back of the slab.
- ⚠ Use slabs from the same batch for the job. This will ensure a colour match. However, to ensure colour matching, always make a visual check before cutting.





**ARCHITYPE**  
more than stone



# 6. Tools and equipment

## 6.1 Mandatory equipment

- Cutting machine with table
- Bridge saw
- Stone transport wagons/trolleys
- Forklift truck or another lifting device
- Tools of different sizes
- Air filtration system
- Industrial wastewater treatment system
- Water recirculation system
- Air compressor
- A settling tank system for industrial wastewater recovery.
- Wall-mounted or hand-held drilling machine mounted on a table

## 6.2 Additional equipment

- CNC machine
- Automated edge milling machine for narrow parts of the product.
- Hydro-abrasive material cutting machine.
- Automated edge milling machine for wide product sections.

## 6.3 Essential tools

- Electric/pneumatic angle grinder for heavy duty cutting and grinding (with speed control)
- Lightweight electric/pneumatic angle grinder for sawing and sanding (with speed control)
- Hand-held electric drill
- Diamond cutting discs in various sizes
- Diamond contour cutters
- Diamond core drill bits of different diameters
- Diamond grinding wheel
- Shaped grinding wheel
- Grinding stone
- Sets of diamond and sanding polishing pads
- Scraper and spatula
- Hammer with square striker
- Angle measuring devices
- Texture brushes / Viento
- Polishing wheels
- Wet edge milling machine
- Storage rack or triangular frames
- Clamps of different size



Contact your local distributor to select the correct diamond tool for cutting Caesarstone slabs



## 6.4 Accessories

- Dyes
- Detergents
- Quartz granules

## 6.5 Bonding material

- Use a polyester resin binder or polyacrylate modified with epoxy adhesive to join the two pieces. Binders such as Tenax, Integra and Impa are suitable for this purpose, matching the colour range.
- Adding a transparent binder to a colour matched binder can improve the properties of the binder.
- To bond a quartz surface to another material, use a flexible adhesive such as 100% silicone or a polyurethane-based adhesive suitable for quartz surfaces.

⚠ Use neutral silicone with an acid-sensitive base such as metal or concrete.

- To ensure that the joint is minimally visible, the colour of the bonding material used must match the colour of the surface. If a suitable bonding material is not available, the colouring agents of the coloured grout can be mixed with the bonding material to achieve the desired colour.

⚠ When mixing the binder to achieve a colour that matches the surface, please note that the colour will be slightly lighter after drying.



# 7. Preparation for fabrication

## 7.1 Planning

- Make sure that the base (the kitchen cabinet in the case of kitchen countertop) is in a stable position and fully prepared to start work on the surface.
- Check that all parts of the base are the right size/shape and correctly positioned.
- To minimise wastage of surface area, try to plan the assembly of the product in an area-optimised manner, taking into account the rectangular shape of the sheet.
- Take into account the process allowance for machining the front edge.

## 7.2 Measurement

- The accuracy of the measurements is essential for the successful fabrication and installation of the surface.
- There are two most common methods of measurement: template measurement and direct measurement as described in sections 7.2.1 and 7.2.2.



### 7.2.1 Template measurement

- Mark the location of the seams on the product.
- Make a solid template for each part of the surface as described below.
- Mark on the template the centre point of the products to be installed later, e.g. sink and hob.
- Check the position and space left for worktop-mounted products, taking into account the distance between the products and the rest of the appliances; for example, the hob should be directly under the extractor hood; the sink under the window unit.
- Mark all relevant information required for fabrication on the template, e.g. whether polishing of the edges, adjoining edges, etc. is required.
- Take a few reference measurements to make sure that the angles and workpieces to be made later in the workshop are correctly positioned.
- Transfer the measurements from the template to the surface of the slab using one of the following methods:
  - Lay the template on the surface of the slab and copy the information.
  - Scan the template with an industrial scanner. The scanner will accurately identify the data and send the information to the computer controlling the cutting machine.



### Making a solid template

Caesarstone recommends making solid templates of a given size from polypropylene sheets using the following technique:

- Place a sheet of polypropylene on the product.
  - The position of the sheet edges must match the seam lines and the edges of the product or the wall.
  - Cut out the template to the required size, taking into account all protrusions and holes.
-  You may have to combine two (or more) polypropylene sheets to create a template of the correct size and shape.
-  Caesarstone do not recommend making templates out of cardboard as they can be easily damaged.

### Making a frame template

- The frame template can be made from any lightweight, stable, rigid material, using plastic strips approximately 70-100mm wide and 2mm thick.
- The position of the strips along the surface must correspond to all protrusions and holes. Join the edges of the strips to the seams of the product.
- Apply glue approximately every 300-400 mm across the entire width of the template to dry quickly. Join the two ends of the horizontal strips to the seams of the product.

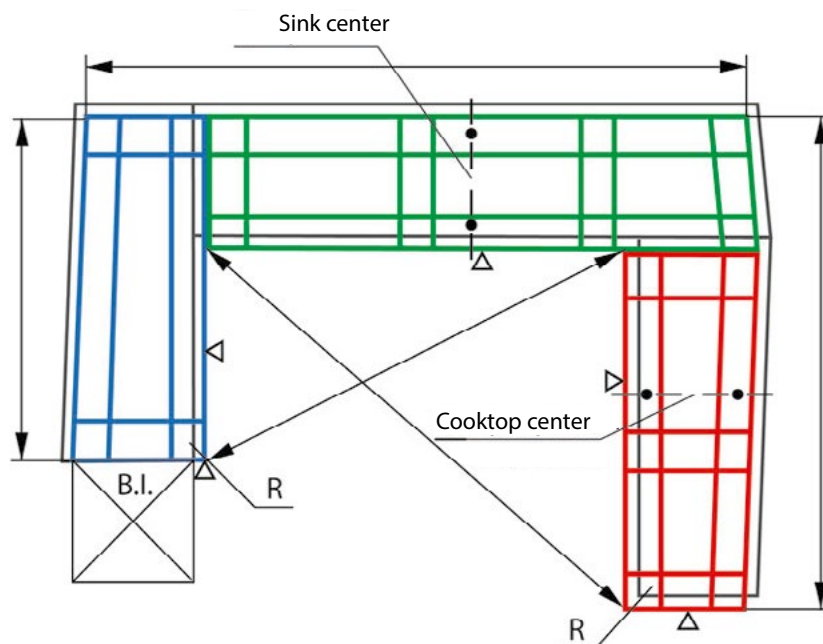

Example template

# Preparation for fabrication

## 7.2.2 Direct measurements

- Make an accurate drawing showing the measurements, preferably on a computer or professional electronic tablet with a marking ruler.
  - Use the front line of the installation as the central line of the drawing, from which all other measurements should be drawn. If the front edge is not perfectly level, draw a level line on the body using it as the central line.
  - Mark on the drawing the centre point of items that will be installed in the worktop, such as sinks and cookers.
  - Check that the sum of the quantities making up one side is equal to the length of the whole side.
- 📏 Be sure to measure all angles, in most cases they are different from 90°. Measure the diagonals of the base or use an angle measure.
- 📏 A 1° deviation from 90° creates a deviation of 52 mm for every 3 m!

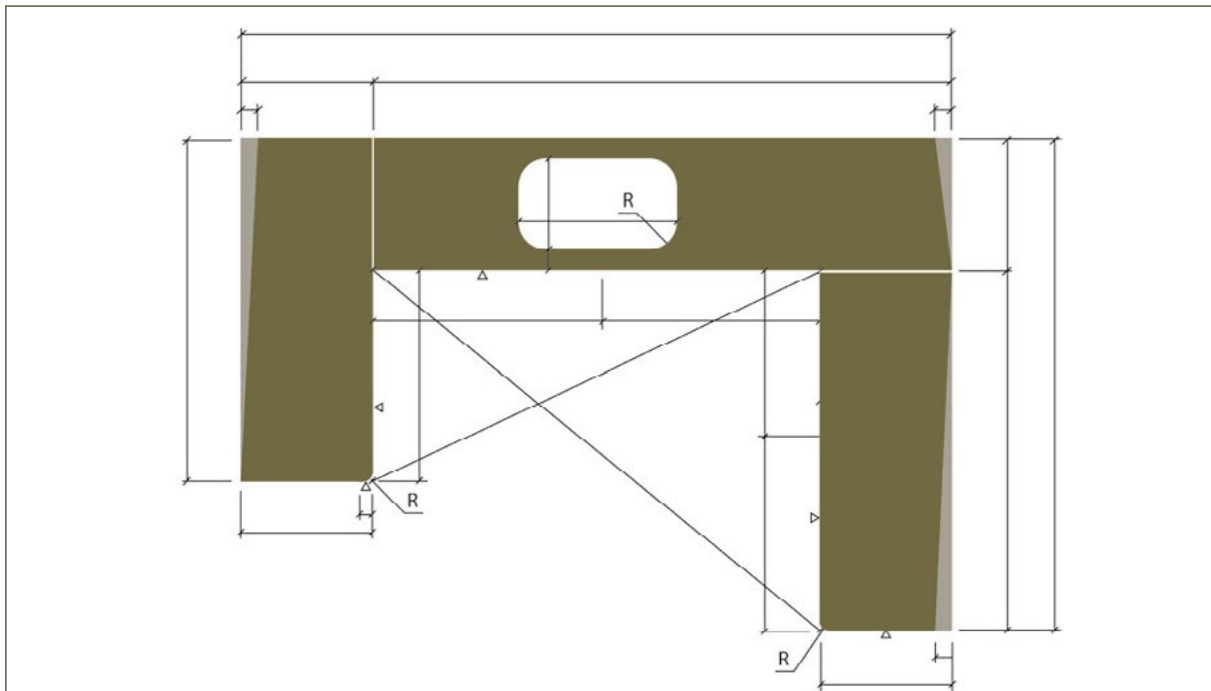

Example drawing with measurements

- 📏 Measurements can also be taken using an automated measuring system, which automatically converts to a product drawing using a computer programme.



### 7.3 Efficient utilisation of the slab work surface

- Plan the arrangement of workpieces installation in such a way as to minimise slab waste.
- Make sure that the surface of the slab in the areas designated for the planned work surfaces of the product fulfils the requirements described above.
- Avoid placing seams or the countertop face at the edge of the slab. Utilize the edge of the slab for the countertop section that will be against the wall.

Example of marking cutting sections with laminated strips

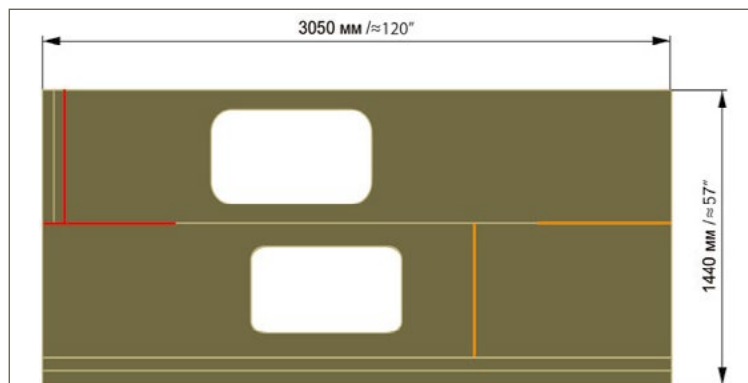

Example of a slab part plan



A worktop up to 7.2 metres long can be made from a single slab.

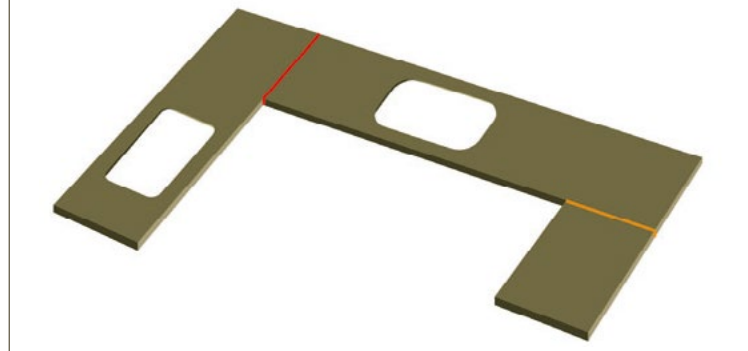

Example of model positioning before cutting the slab



# 8. Fabrication

## 8.1 Cutting the slab

- Begin by cutting a minimum width strip of stone from the outer edge of the slab. This evens out the edges and establishes a base for subsequent work.
- Proceed with cutting the slab according to the provided drawing or specifications.

⚠ After the slab has been sawn, check the colour matching of the pieces for later joining.

⚠ To prevent overheating and the generation of excessive dust, only use water-cooled tools for cutting.

🔧 Maintain the sharpness of diamond cutting tools by utilizing a flint stone for this purpose.



### 8.1.1 Straight line cutting

- Cutting in a straight line must be done with a flat diamond disc attached to a table-mounted cutting machine or an overhead saw.
- Cut in a straight line using a flat diamond disc attached to a suitable angle grinder.

🔧 Make sure that the diameter of the diamond disc used corresponds to the machine and the material

### 8.1.2 Curved line cutting

- Curved cutting is performed with one of the following devices:
  - CNC machine with diamond cutter
  - Water jet cutting machine
- Cut in a curved line with one of the following devices:
  - Shaping and milling machine with diamond cutter
  - Grinding wheel with concave diamond disc
  - A grinding wheel with a concave diamond disc attached to an angle grinder.

### 8.1.3 Cutting holes

- The holes are cut with one of the following devices:
  - Drilling machine with diamond core drill bit
  - CNC machine with diamond core drill bit
  - Water jet cutting machine
- Cut the holes by hand using a carbide-tipped drill bit (for small holes) or a diamond core drill bit attached to a suitable angle grinder or hand drill (for large holes).





## 8.2 Seam joints

- To obtain a high-quality joining seam, it is recommended to «open» the seam from the inside, 2-3mm short of the front/working surface of the product. The resulting gap allows for a smooth joint surface and leaves a gap for the bonding material at the bottom.
- ⚠ For 20mm and 30mm thick slabs, create a recess in the middle of the joint edge that does not touch the visible part of the outer edge of the slab. This creates a gap where the joint bonding material is placed; see diagram.
- ⚠ For 13 mm thick slabs, glue a laminated strip (technological underlay) at the bottom along the entire length of the joint.
- ⚠ Do not polish joints on Caesarstone surfaces

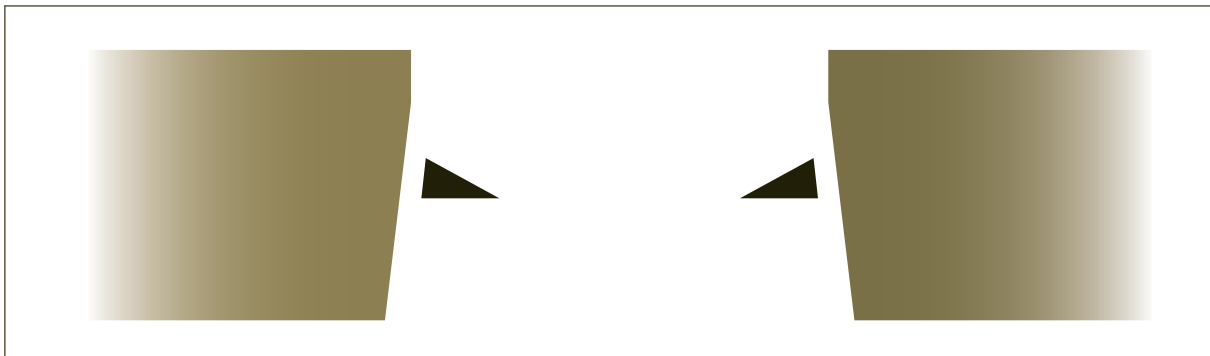

## 8.3 Inner corners

- Always construct an L-shaped or U-shaped work surface with a seam at the inside corner of the slabs.
- Make a seam joint at any change in surface direction.

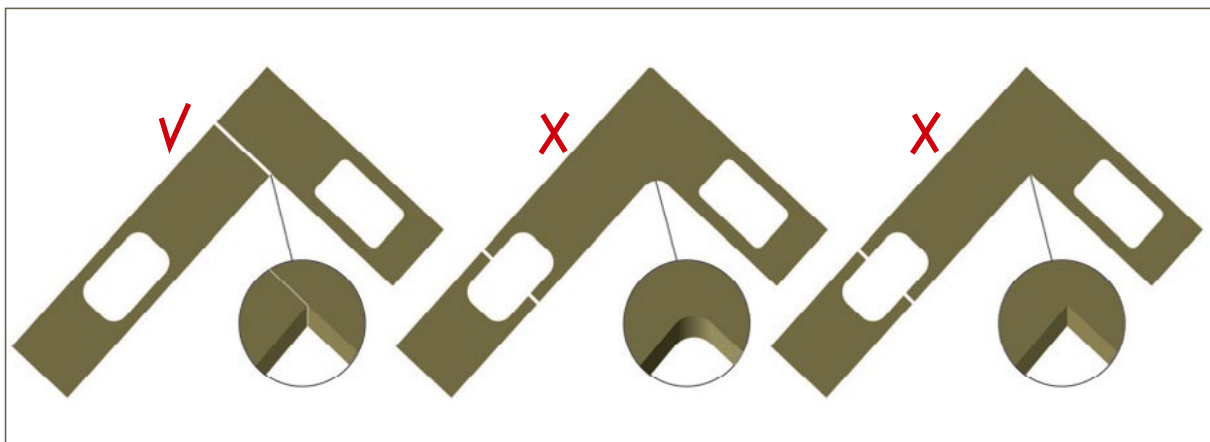

# Fabrication

## 8.4 Cut-outs

As a rule, cut-outs in the worktop are made for the installation of a sink, cooker and other accessories.

- Make the cut-outs according to the instructions in the installation manual.
- Make a minimum radius of 15 mm at each corner of the holes; see Figure 1. The larger the radius, the stronger the corner.

⚠ In the event that making a 15mm corner radius in the hole will prevent proper installation of an item requiring a 90° angle, use a core drill to drill a hole outside the corner; see Figure 3.

⚠ Take care not to go beyond the rounded edge of the cut-outs; see Figures 2 and 4. Damage to the area can lead to the formation of micro cracks.

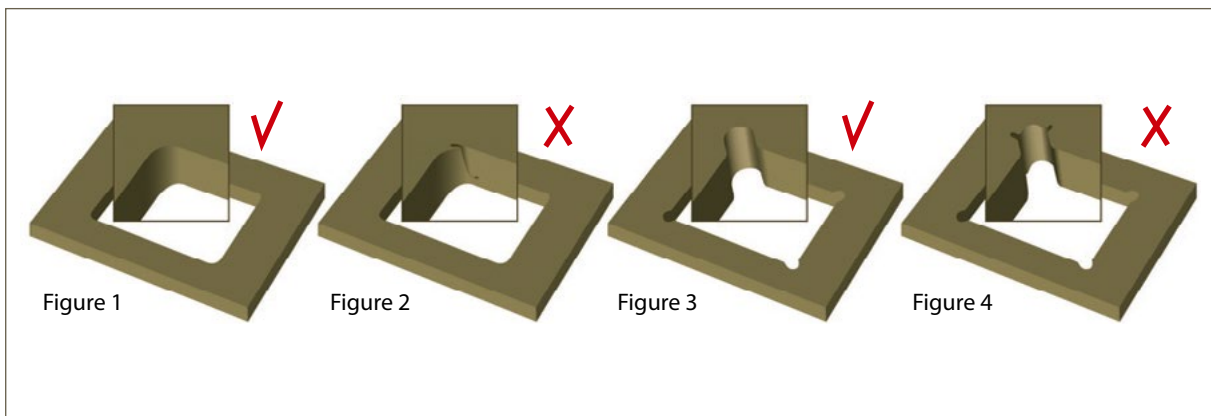

⚠ Do not reduce the thickness of the surface while making cut-outs.

⚠ The distance between the cut-out and the edge or seam must be at least 60 mm. The greater the distance, the stronger the section.

⚠ If the distance between the cut-out and the edge or seam is less than 150 mm, this area must be reinforced by means of a technological underlay: ensure that the area between the cut-out and the edge or seam is positioned above the main body parts; or organise a solid support.

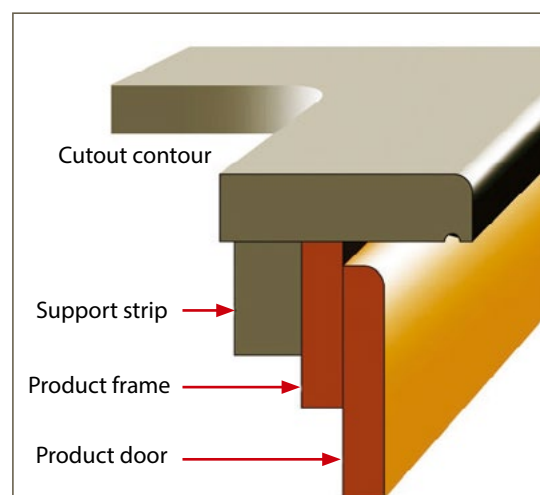



### 8.4.1 Method for creating cut-outs for accessories

These cut-outs are usually required for the installation of various equipment such as a sink or a cooker, for example. There are three main installation methods, each of which requires a specific type of cut-out to be made:

#### Mounting from below

- According to the type of installation, the product is positioned under the worktop.
- A cut-out with a diameter slightly smaller than the product to be installed is made, so that the joints are not visible when the work is finished. The edges of the cut-out must be rounded and polished.

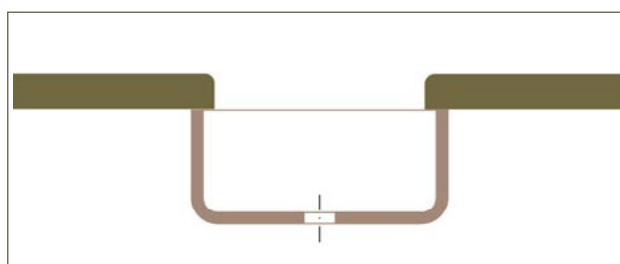

#### Mounting from above

- According to the type of installation, the product is positioned above the worktop.
- The edges should be levelled with a grinding wheel and not polished. Leave a small gap between the product wall and the worktop.

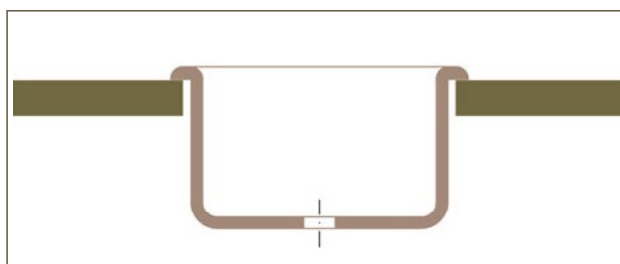

#### Built-in installation (one level installation)

- In this type of installation, the product is installed almost or completely flush with the worktop, in a cone-to-cone or flat installation pattern «quarter». When installed cone to cone, the edge of the product should be slightly wider on the top edge than the bottom edge.
- It is necessary to make a cut-out at a slight angle to create a cone shape so that the

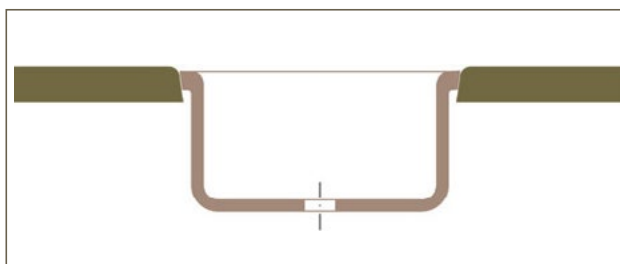

the neckline will be wider at the top than at the bottom. The product can be built into the cut-out. The size of the cut-out is determined by the position of the product in relation to the surface.

 Caesarstone recommends installation so that the product sits just below the worktop and does not protrude from the top.

 Do not attach the product to the worktop by polishing or reducing the surface.

# Fabrication

## 8.5 Edge polishing

Follow the edge polishing recommendations below to achieve a polish identical to the factory polish:

⚠ Never polish the front (working) part of the surface, only the edges!

- Make sure that the area prepared for polishing is clean.
- Use water-cooled tools for polishing; dry polishing can overheat the surface and damage it.
- Use the appropriate diamond polishing pads together with water.
- Use the polishing wheel to polish rounded or curved inside corners and small cut-outs with an outside edge.
- Polish by changing the number of the grinding grit from coarse grit (lower number) to fine grit (higher number).

🔧 If a significant amount of material is to be removed from the edge, before using the coarsest possible pad, it is necessary to use a diamond grinding wheel.

- Each polishing step should remove traces of the previous step. When you have achieved a uniform finish, proceed to the next step.

🔧 The use of a polishing wheel is not recommended for hand polishing.

- Do not polish the edge contour over the factory polish.
- Polish the edge contour in increasing degrees, according to the table below.

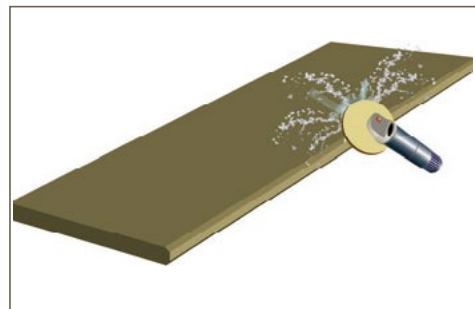



### 8.5.1 Polished finish

- The polished finish is smooth and shiny.
- Use **diamond** polishing **pads** for **polished** finish.
- Avoid excessive polishing, e.g. with a 3000 grit pad, as this may cause the polished part to be shinier than the surface itself.

Accessory	Grit size
Green diamond polishing pad	60
Black diamond polishing pad	80
Red diamond polishing pad	120
Yellow diamond polishing pad	400
White diamond polishing pad	800
Blue diamond polishing pad	1500



### 8.5.2 Matte finish

- The matte finish is smooth but not shiny.
- Use **diamond polishing pads** and professional polishing brushes for matte finish.
- Operate brushes at 600-1200 rpm using plenty of water.

 The brushes listed below are used for matte or textured finish.

Accessory	Grit size
Green diamond polishing pad	60
Black diamond polishing pad	80
Red diamond polishing pad	120
Yellow diamond polishing pad	400
Professional polishing brush	120
	200
	300
	500



### 8.5.3 Textured/Viento finish



- The textured/Viento finish has a slight grain and a slight polish
- For textured/Viento finish, **diamond polishing pads and diamond polishing brushes** can be used.
- Operate brushes at 600-1200 rpm using plenty of water.

Accessory	Grit size
Green diamond polishing pad	60
Black diamond polishing pad	80
Diamond polishing brush	60
	120
	400
	800



# Fabrication

## 8.6 Edge fabrication

- All raw edges must be manufactured with the same finish as the surface.
  - All corners should be rounded or bevelled. Do not make a rectangular edge.
  - All edges must have a minimum edge contour of 3 mm.
-  The main part of the edge elements is rounded or at a 45° angle; either way, there is a wide range of design detail choices.
-  The greater the surface area of the edge, the more resistant it is to chipping.
- To prevent water/liquid from overflowing over the edge of the enclosure, we recommend installing a water drain (drip tray) under the front edge of the worktop. Placement of the gutter is approx. 13 mm from the front edge.

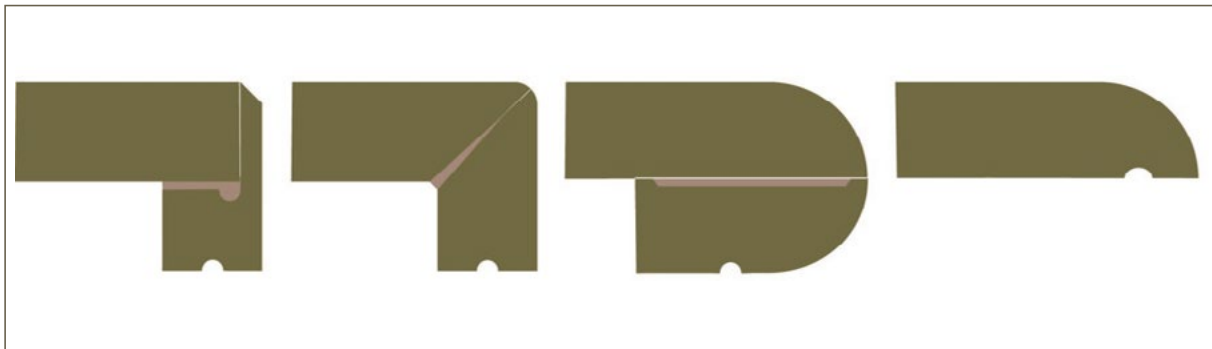

### 8.6.1 Single edges

- A single edge has the thickness of a slab.
- Single edges can be produced quickly and easily.
- The largest number of automated machines have been developed to create these edges.

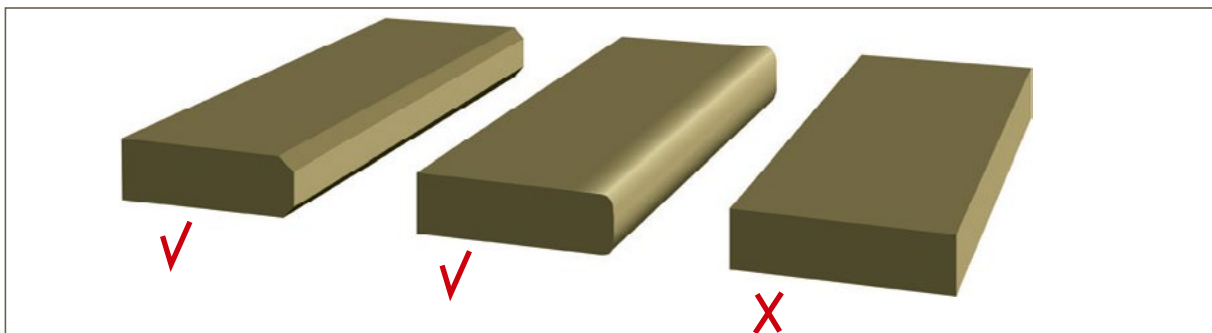



### 8.6.2 Laminated edges

Laminating is the process of gluing one or more strips of Caesarstone along the bottom edge of another piece of Caesarstone to create a visually thicker slab. It is a complex process that is more time-consuming than the single edge fabrication process; however, it results in a stronger aesthetic effect.

- To match the colour, cut the lamination strips from the same slab as the countertop.
- The lamination strip must be the same length as the workpiece to which it will be attached. The joints of the strips will thus be aligned in line with the surface seam. However, if it is necessary to create a lamination strip from more than one workpiece, make a diagonal joining line at an angle of 45°.
- Cut the lamination strips at the outer corners at an angle of 45°.
- If a lamination strip interferes with the opening of the product door, raise the surface using a lifting/ supporting (technological underlay) strip along the full length of the front and back of the enclosure. Plates must be 70 mm wide and the same height as the lamination strip.



The lifting/supporting strips are recommended to be made of quartz stone.

- The preferred method for laminating edges is miter cut, see section 8.6.2.1

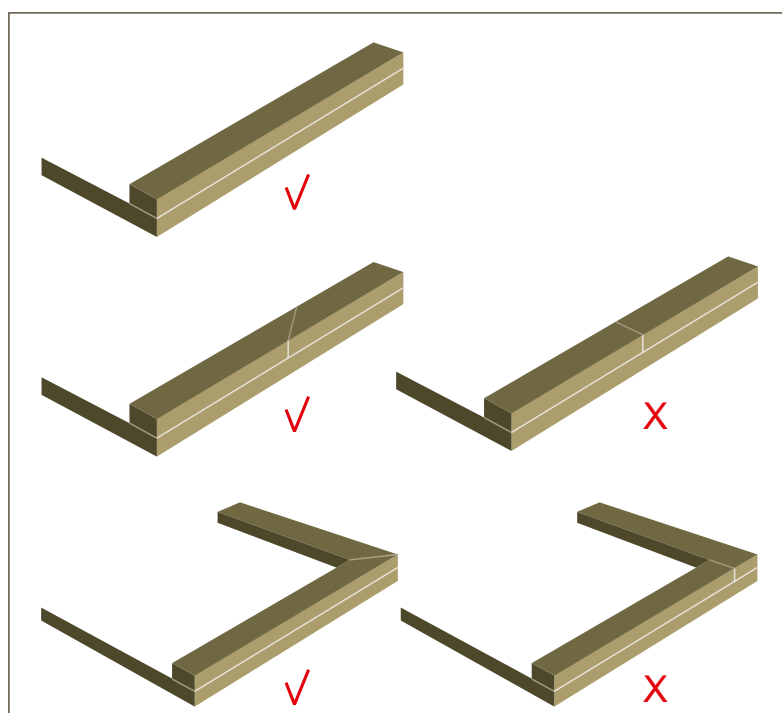
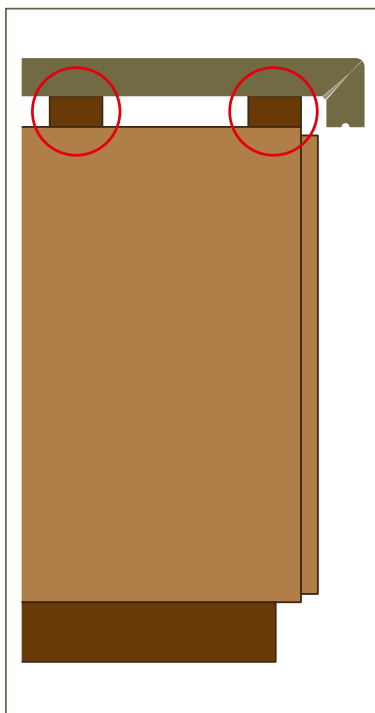

# Fabrication

## 8.6.2.1 Miter edges at a 45° angle

### Characteristics of miter edges at 45° angle

- Miter edges with 45° underglue can be produced to any height. The edge height is independent of the slab thickness.
- Miter edges with a 45° underglue allow the pattern to continue along the entire edge.
- Miter edges with 45° underglue can be used to create edge contours with a variety of shapes and depths.
- No polishing of the vertical part of the cut is required as only the polished surface of the slab is visible.







### Fabrication of miter edges

- Cut a strip from the slab, the width of which should be the same as the height required for the miter edge with a with a 45° underglue.



For a miter edge with a 45° underglue Motivo or Concetto, cut the slab where the corner joint is planned to allow the pattern to continue.

- To maximise strength and form a finished edge at a 90° angle, fabricate a corner/

a bevelled edge at an angle of 45°. An edge angle of less than 45° is prone to chipping.

- After cutting at a 45° angle with a hand tool, the angle at the back of the bevel should be reduced slightly to create a gap for the bonding material. This will contribute to a strong bond and seal on the visible part of the cut.
- Polish the joint to the radius or bevelled edge as indicated.



Due to the connection in the middle of a small radius or cut, the edge becomes prone to chipping. Therefore, it is recommended to create a large radius.

- For maximum strength, spread the bonding material evenly over the entire surface of the joint.



To prevent the binder material from protruding to the surface and to create a precise 90° angle, it is recommended to use a clamp, e.g. a clamp manufactured by J. Koenig; <http://www.j-koenig.de/>.

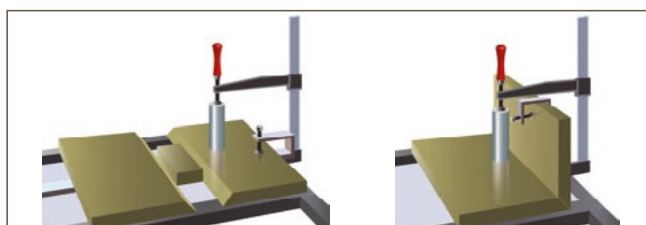
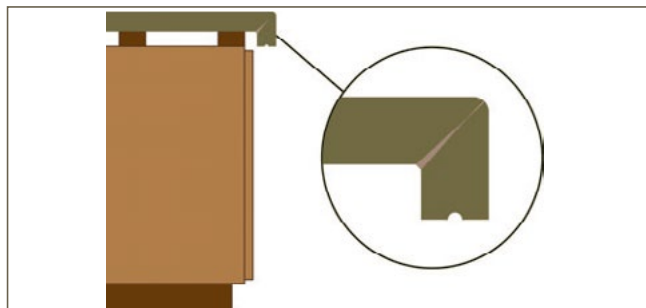
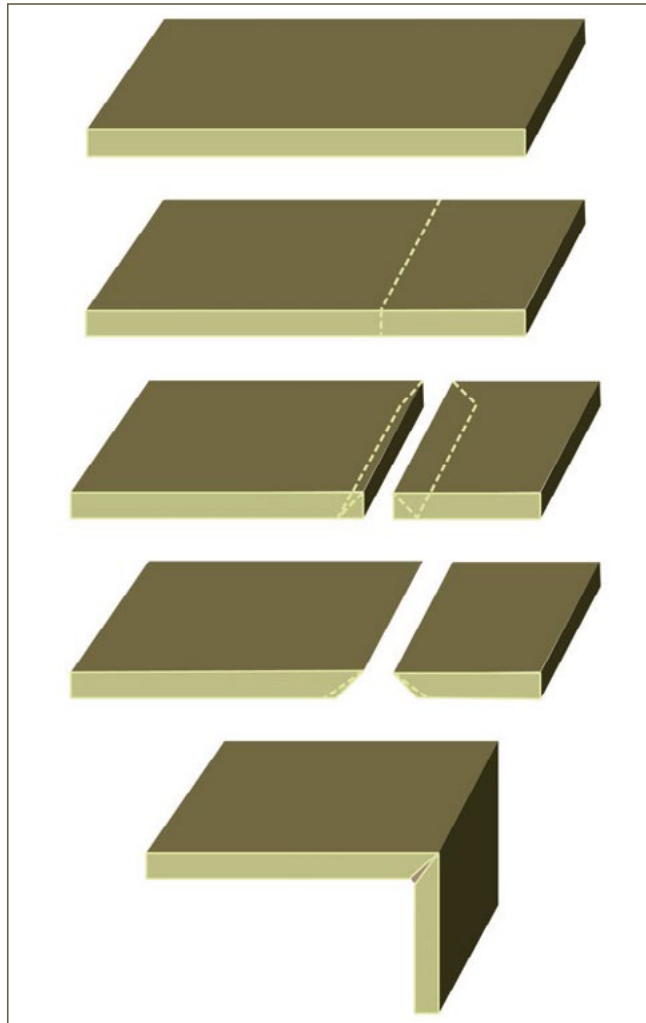

# Fabrication

## 8.6.2.2 Multilayered edges (“sandwich” underlayment)

### Characteristics of multilayered edges

- Multilayered edges are made by gluing one or more lamination strips under the outer edge of the surface.
- Edges with three or more strips allow a variety of design solutions, such as using lamination strips of different thicknesses and/or colours, by grinding one or more recesses in the lamination strips.
- This method is used to create a common double rounded edge.

### Fabrication of multilayered edges

- Before bonding the lamination strip to the underside of the surface, make a cut in the stone approximately 3mm behind the edge to ensure that the visible joint is fully sealed and to create space for the bonding material.

-  Leave the strip unchanged in a few areas to maintain the integrity of its thickness when attached to the surfaces.

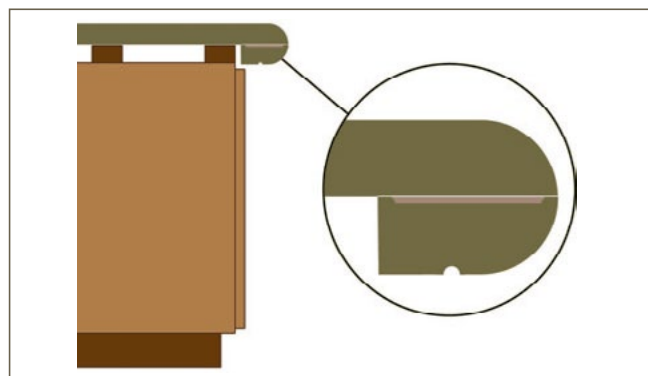

Cross section of laminated double-layer edge

- Place the lamination strip with the bottom surface sampled to ensure the joint is sealed.

If the joint is not perfectly tight, the joint areas should be levelled until there are no protrusions.

- Glue the lamination strip to the surface.
- To create an even finish and mask the bonding material, press the strip against the surface in several places at the top and bottom.
- After the lamination strip has been glued to the surface, polish the entire visible surface of the edge.





### 8.6.2.3 L-shaped edges

#### Characteristics of L-shaped edges

- L-shaped edges have the following characteristics, which are similar to those of miter edges with 45° underglue:
- L-shaped edges can be produced to any height. The edge height is independent of the slab thickness.
- L-shaped edges allow the pattern to be extended from the work surface of the product to the edge.
- No polishing of the vertical part of the cut is required as only the polished surface of the slab is visible.
- L-shaped edges are different from the 45° underglue miter edges:
- The main difference between L-shaped edges and 45° underglue miter edges is that the L-shape is easier to produce, as the slab is sawn at the standard 90° angle on one side only.

#### Fabrication of L-shaped edges

- Cut a lamination strip from the slab. The width of the strip should be the same as the height required for the L-shaped edges.

 For a Motivo or Concetto L-shaped edge, cut the slab where the corner joint is planned, to allow the pattern to continue.

- To create a protrusion of at least 3 mm on the polished side, cut a quadrangular piece from the strip as follows:
  - Cut across the width of the strip in such a way that the planned depth of the protrusion remains (at least 3 mm) with an additional 2 mm added. For example, in a 20 mm thick slab the maximum depth of the cut-out will be 15 mm.
  - Cut along the length of the strip to a depth equal to the surface thickness with 2 mm added.

 The combination of the cuts described above ensures a precise 90° angle and the strength of the ledge. The thicker the ledge, the stronger the edge.

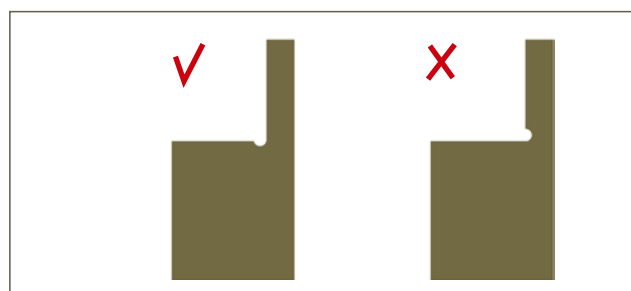
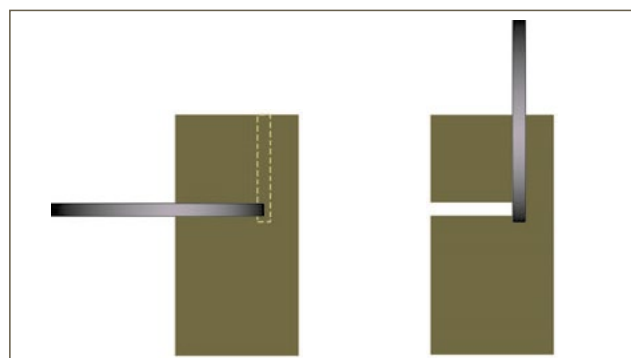
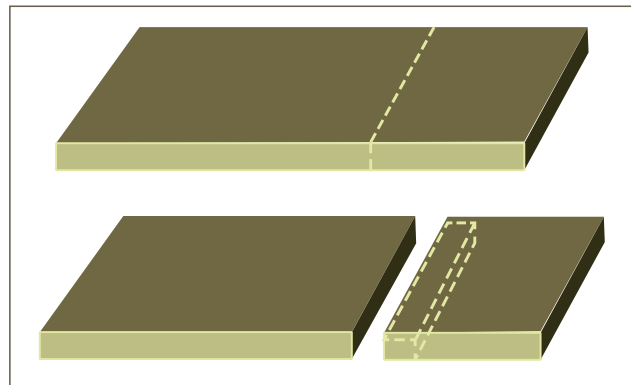

# Fabrication

- Glue the lamination strip to the surface. Use clamps to

press it against the surface in several points from the outer edge of the strip to the back edge of the surface. This will ensure a strong connection and the bonding material will not be visible.

- Polish the radius or chamfer of the L-shaped edge as indicated.

-  A bevelled edge is preferred for L-shaped edges.

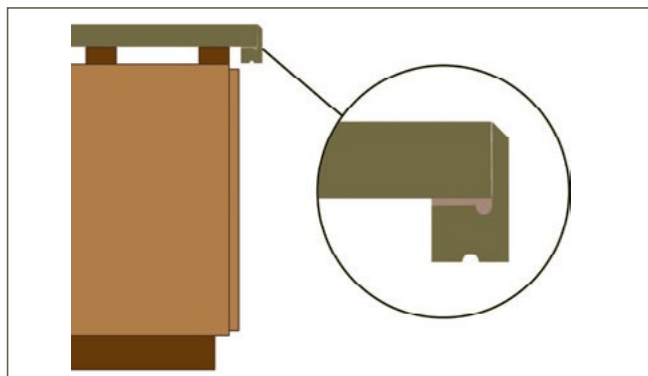
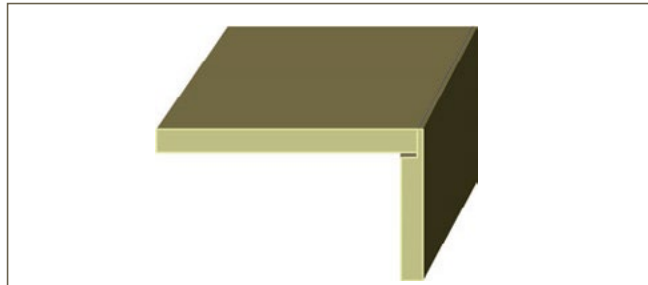

Cross section of the L-shaped edge

## 8.7 Transportation of finished surfaces

The correct handling of the finished products is essential for transporting them safely to the job site.

- Ensure that there is a protective layer between the stand and the finished products to prevent chipping or other damage to the surface during storage or transportation.
  - Load the finished products into a machine equipped with a triangular frame with cross braces appropriate for the size and weight of the slab. Some triangular frames can be removed from the loading machine.
  - Place the finished products on the stand with the front side facing in and the back side facing out. Each piece should be supported by an adjacent piece. Place items with cut-outs in the middle of the set to protect them from other items.
  - Securely tie the products to the stand to avoid wobbling during transportation. Ensure that the straps are not damaged or cut against the rectangular edge of the slab.
  - Securely fasten the entire batch with the strap on the loading machine.
-  The slabs must be securely fastened to avoid falling during loading due to forklift movements or strong winds.



**ARCHITYPE**  
more than stone



# 9. Installation

## 9.1 Preparation of basic parts

Below are technical data and information related to some common applications of Caesarstone products. For any other questions you may have, please contact your local distributor.

- Countertops are mounted on top of the product and are not attached to the wall.
- Before installation, make sure that the furniture frame is fully assembled, is in a stable position and can support the weight of the countertop. The bases must be fully assembled and connected to each other.

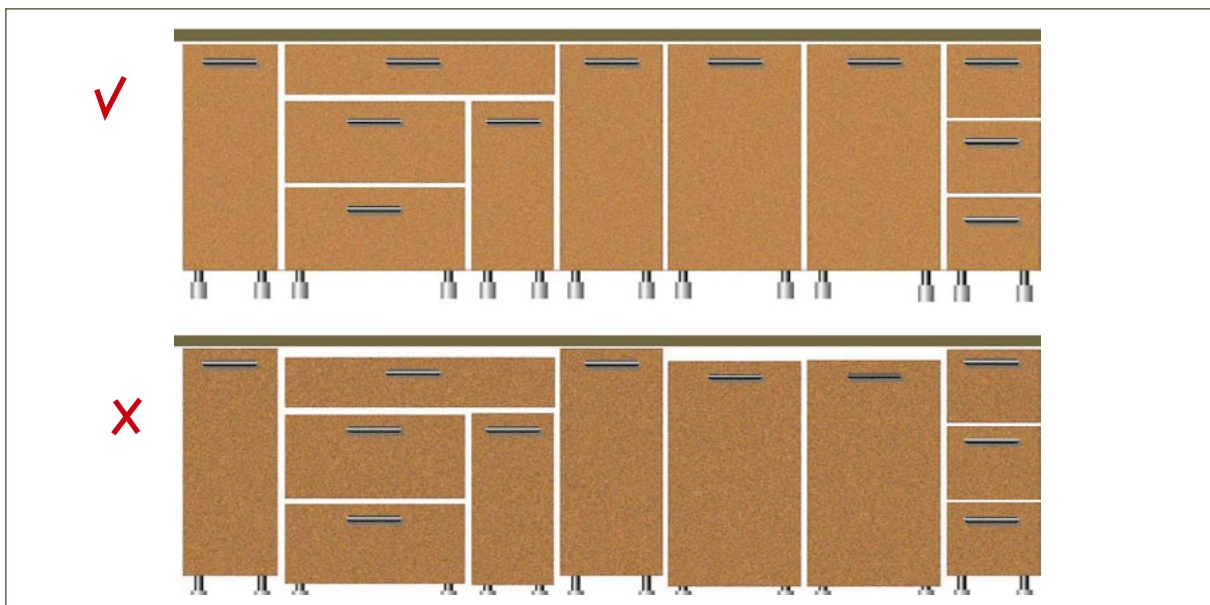

- For additional support, countertops should be attached to a tight frame installed around the perimeter of the product or to a supporting plywood base.
- Make sure the countertop is sufficiently reinforced at joints and openings for the installation of appliances such as dishwashers, cookers, washing machines, etc.
- Front and rear support brackets must be installed every 500-600 mm.
- ✂ Examples of such supporting fixtures are cross members of furniture bases; a cantilever attached to a wall; a vertical countertop located on a floor panel.
- For openings larger than 600mm, it is necessary to install support from one side to the other under the worktop.
- It is also very important to install additional supports around the perimeter of the seam joints.
- It is necessary to install a wooden slab between the upper surfaces of the compartments on either side of the adjacent heating units.
- If there is a need for additional reinforcement for 13 mm and 20 mm countertops, install an additional sheet of plywood at least 16 mm thick at the top of the product or glue the surface from below with strips of quartz material. For 30 mm countertops, additional sheets are not necessary.

## 9.2 Countertops

### 9.2.1 Preparation for installation

- Place all the fabricated countertop parts as they should be positioned on the product, without adhesive. Make sure that all parts are the right size, shape and positioned correctly in relation to the product and the adjacent wall.
- Check that all outer edges and corners are ready for installation and rounded as required.
- Make sure the surface is completely flat, you can check this with a long ruler and spirit level.
- Leave a 1 mm gap between the surface and the walls for possible expansion and contraction of the walls, but in any case at least 3 mm.
- Before attaching the countertop to the product, carefully check all the parts again to make sure you are satisfied with everything.

### 9.2.2 Seam joints

- Slightly pull the countertop pieces apart from each other along the seam.
- Place a layer of paper over the seam joints to prevent the adhesive from getting on the product.
- Select a colour-matched polyester resin adhesive.



If necessary, mix the adhesive with the pigment with a metal or plastic spatula until the desired shade is obtained.



Use plastic spatulas for light colours.

- Make sure that the seams are free of dirt.
- Apply a thick layer of adhesive to both sides of the seam.
- Make sure the grooves in the middle of the seams are filled with adhesive.
- Securely seal the seam and straighten it out with clamps or professional fixers until the surface is perfectly smooth.



Do not treat large areas of the surface with adhesive. Only small moving parts of the countertop can be securely connected to the kitchen unit using an elastic adhesive, e.g. 100% silicone.

- Once the adhesive is completely dry, remove the clamps.
- Remove any adhesive residue with a scraper.
- Wipe the surface with a piece of clean white cloth soaked in alcohol.



Do not polish seams.

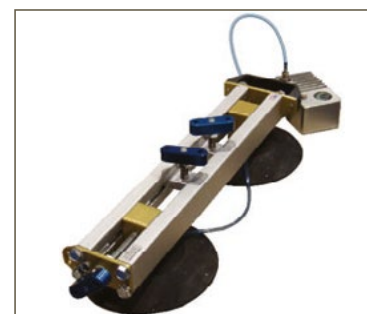

# Installation

## 9.2.3 Surface connection to the wall

- Thoroughly clean the space between the surface and the wall.
- Fill it with an elastic adhesive such as 100% silicone.
  - 🔧 Silicone adhesive prevents water from penetrating into the product.
  - 🔧 If you want the joints between the Caesarstone surface and another surface to be visible, use coloured silicone or a suitable acrylic mastic.
- If the furniture legs are adjustable, make sure they are in a stable position.

## 9.3 Sinks

- Install and use adhesive to firmly secure the sink according to the manufacturer's instructions, after the countertop has been installed.
- Use a suitable elastic adhesive to attach the sink to the countertop.
- Make sure that in addition to the countertop, the sink is also securely fastened inside the product, for example with support rails or legs.
  - ⚠️ Make sure there is enough space left after installation and you can easily reach everything below, e.g. sink, bolts, detergent bottle, etc.





## 9.4 Accessories and fastening elements

Accessories and fittings can be attached to Caesarstone surfaces using mechanical fasteners, fixing adhesive, or both.

- Combine both methods when attaching heavy accessories to the surfaces.

### 9.4.1 Mechanical attachment of accessories

- Drill holes of the required size and shape. This can also be done after the slab has been installed.

 This can also be done after the slab has been installed.

- If the back of the slab is accessible (e.g. sink, countertop, etc.), route the wires through the slab and fix them to the back using a suitable fixing provided by another manufacturer.

 It is not necessary to apply excessive force, as increased pressure can damage the surface

 Use pads or other pressure distributor to avoid over-pressurising a small area.

- Where the back of the slab is inaccessible (e.g. floor and walls), secure accessories to the backing plate with corrosion-resistant screws or bolts of an appropriate size and strength level or use sliding screws and sliders.
- For holes not exceeding 40 mm, a gap of at least 50 mm is required between the hole and the edge of the surface/cut -out to maintain surface strength. For larger holes, the minimum distance to the surface should be increased according to the proportions.

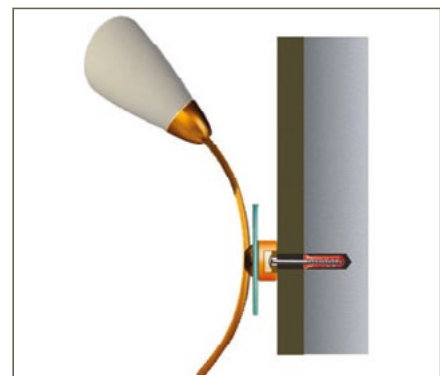

 Do not attach elements of mechanical fasteners (bolts, nails, etc.) directly to the Caesarstone surfaces. If it is necessary to guarantee the connection, use elastic adhesive only.

# Installation

## 9.4.2 Attachment of accessories using bonding materials

- Most accessories are supplied with an integral self-adhesive pads, which can be attached directly to the surface.
- If the accessory is supplied without them, you must attach the accessory to the surface using a suitable adhesive, e.g. 100% silicone.

 The larger the bond area, the stronger the bond.

## 9.5 Overhangs

An overhang is a structure that is not supported on any side/console structure: e.g. a surface that extends beyond the edge of the base of the product and is used as a countertop.

- Extra strength can be provided by laminating the edges or attaching an additional slab of the same thickness underneath. In this case, the bottom slab is attached back to back underneath the surface, so that the polished surface is exposed underneath the slab.
- The permitted overhang dimension must be decided by a professional. The decision depends on a number of factors such as:
  - Length and width of the surface in relation to the length and width of the overhang.
  - The stability of the base or other support fixture that sustains the overhang.
-  13 mm overhangs require more support than 20 or 30 mm. Fix them with Caesarstone strips or a metal frame.
- The table below gives approximate calculations for the overhangs.

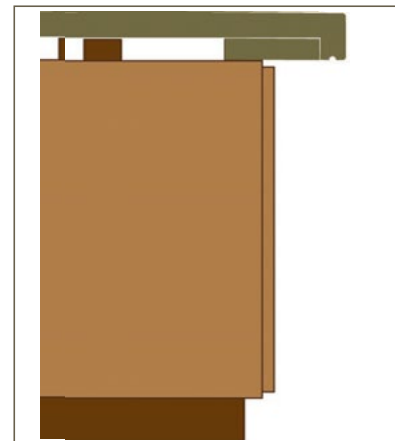

Slab thickness 20 mm	Slab thickness 30 mm	Necessary support
<300 mm	<400 mm	No additional support is required
300-500 mm	400-600 mm	Support rackets at 600 mm intervals
>500 mm	>600 mm	Legs, columns or panels

## 9.6 Work surface of the table

- When installing a Caesarstone surface as a stand-alone worktop, it is necessary to consider the base on which it will be fixed, or a support that will be able to sustain it.
- Apply 100% silicone evenly to the top edge of the support leg. Make sure the adhesive is evenly applied over the entire surface to ensure adhesion.



## 9.7 Finalising installation procedures

- After the installation is complete, make sure the slab surface and work surface are completely cleaned up.
- If further work is to be carried out on the same work surface, ensure that the Caesarstone surface is completely covered with corrugated cardboard or another protective material.
- Please make your customer aware that the worktop should not be used as a work bench, step or standing platform in the future, nor should strong solvents or adhesives be used.
- Caesarstone strongly advises its customers to confirm in writing that there are no defects at the end of the work carried out and that they are completely happy with the material, in order to avoid possible claims in the event that damage has been caused by others.
- Make sure you provide the customer with a care instructions and a document confirming the limited warranties.

## 9.8 Demonstration label

Remember! Always apply the official Caesarstone demonstration label after completing your work.



- The label should be attached to the vertical edge of the slab (right or left).



# 10. Care and maintenance

## Strength - yes, indestructibility - no.

For regular maintenance of Caesarstone surfaces, we recommend the use of water and a mild detergent or high-quality spray and cleaning wet wipes. For stubborn stains, use a non-abrasive cream or cleansing gel. Consult your distributor for specific products recommended for your local market.

- The permissible pH level of all detergents should be between 5 and 9. Products with pH levels outside this range may damage the surface.

 If agents outside this range are used, as recommended in Section 10.4.2, pre-test their effect on a small area of the surface.

- It is recommended not to leave detergents on the surface for more than 5 minutes.

 If it is necessary to leave the product for more than 5 minutes, test its effect on a small area of the surface beforehand.

- Do not use products containing trichloroethane or dichloromethane, such as solvent or adhesive or varnish remover.
- If one of these hazardous substances accidentally comes into contact with a surface, it must be rinsed immediately with water to neutralise their effects.
- Do not allow dirt to remain on the Caesarstone surface for long periods of time.
- Products containing oils or talcum powder may leave residues, so rinse the surface thoroughly after using such substances.
- After cleaning, thoroughly rinse the cloths you used to wipe the Caesarstone surface.

## 10.1 Resistance to thermal impact

Caesarstone products are resistant to moderately high temperatures for short periods of time. Prolonged exposure will result in discolouration or other types of damage. Excessive localisation of heat may result in product damage or micro-cracking.

 Do not expose Caesarstone products to temperatures exceeding 100°C.

 If the surface is exposed to temperatures exceeding 70°C, reinforce it from below to avoid deformation.

 Avoid direct contact of the product with hot cookware, such as pots. Always use insulators/pot stands.



## 10.2 Resistant to mechanical damage

Caesarstone products are highly resistant to mechanical damage, however, the use of sharp objects such as knives or screwdrivers directly on the surface should be avoided.

## 10.3 Matte, textured / Viento and Motivo finished products: care and maintenance

These surfaces require more maintenance than regular polished surfaces due to their structure.

- Most stains can be easily removed with regular detergents. For stubborn stains, use a medium-hard sponge.
- To make maintenance easier and minimise the possibility of stains or finger marks that occur with regular use, a colour enhancer or protective film can be used.



Due to the fact that these types of surfaces are more susceptible to contamination and damage than regular ones, it is recommended to cover the surface with a protective film during manufacturing process.

## 10.4 Difficult to remove or dried stains

Caesarstone products are highly resistant, so stains that appear on them can be easily removed.

- Before treating the stain with the method below, try first removing the stain using a damp soft cloth wipe and soap or a non-abrasive cleaner.
- If the mark is left by food, adhesive, nail polish or if it is dried paint, you should first clean the surface gently with a sharp scraper and then follow the instructions below.

### 10.4.1 Recommended stain removers

Please consult your local distributor for agents equivalent to those listed below.

Stains of organic origin.

- Cif Bathroom Mousse or similar product
- Astonish granite and marble cleaner and polisher (in black bottle) for coloured stains

Chemical stains

- Mild alcohol-based cleaning agent, e.g. Windex
- Alcohol
- Cleaning agent Interflon EM30 +

# Care and maintenance

## 10.4.2 Stain treatment

Stain type	Cause/source of contamination	Processing/comments
Chemical	<ul style="list-style-type: none"> <li>• Products containing alkali pH 10-14</li> <li>• Fats/degreasing agents, e.g. oven cleaners</li> </ul>	Cannot be removed
Thermal - direct and indirect	<ul style="list-style-type: none"> <li>• Hot pressure cooker</li> <li>• Hot pan</li> <li>• Hot pot</li> <li>• Polishing</li> <li>• Toaster</li> <li>• Grill</li> <li>• Electric cooker</li> <li>• Ovens and baking trays</li> <li>• Hot foodstuffs</li> </ul>	<p>The level of difficulty of a stain can usually be determined by its colour.</p> <p>Yellow stains can sometimes be removed with Astonish.</p> <p>Brown stains usually cannot be removed.</p>
Oils of natural origin	<ul style="list-style-type: none"> <li>• Olive oil</li> <li>• Canola oil</li> </ul>	<ul style="list-style-type: none"> <li>• Astonish</li> <li>• 10% bleach</li> <li>• Hydrogen peroxide min. 30%</li> <li>• Mild alcohol-based cleaning agent</li> </ul>
Synthetic oils	<ul style="list-style-type: none"> <li>• Engine oil</li> </ul>	<ul style="list-style-type: none"> <li>• Astonish</li> <li>• Mild alcohol-based cleaning agent</li> </ul>
Cosmetic	<ul style="list-style-type: none"> <li>• Shampoos</li> <li>• Medical creams</li> <li>• Cosmetics</li> </ul>	<ul style="list-style-type: none"> <li>• Alcohol</li> <li>• Astonish</li> <li>• Hydrogen peroxide min. 30%</li> </ul>
Metal	<ul style="list-style-type: none"> <li>• Metal kitchen utensils, e.g. knives</li> <li>• Metal pots</li> <li>• Metal belts and buckles</li> </ul>	<ul style="list-style-type: none"> <li>• Astonish</li> </ul> <p>Metallic stains may look like scratches in texture, but they are residue that can be easily removed</p>
	<ul style="list-style-type: none"> <li>• Rust</li> </ul>	<ul style="list-style-type: none"> <li>• Oxalic acid</li> </ul> <p>You may have to repeat the cleaning procedure several times if the stain does not come out on the first attempt</p>
Leftover foodstuffs	<ul style="list-style-type: none"> <li>• Food colours</li> <li>• Spices</li> <li>• Red wine, pomegranates</li> </ul>	<ul style="list-style-type: none"> <li>• Astonish</li> <li>• 10% bleach</li> <li>• Hydrogen peroxide min. 30%</li> <li>• Mild alcohol-based cleaning agent</li> </ul>
Arising from defective goods	<ul style="list-style-type: none"> <li>• Pigment regulator disorder</li> </ul>	It is necessary to drill out the damaged piece and repair it (see manual)
Coloured	<ul style="list-style-type: none"> <li>• Ink</li> <li>• Water-based markers</li> <li>• Oil-based markers</li> <li>• Paints</li> <li>• Printing on a supermarket bag</li> </ul>	<ul style="list-style-type: none"> <li>• Alcohol</li> <li>• Astonish</li> <li>• 10% bleach</li> </ul>
Other	<ul style="list-style-type: none"> <li>• Blood</li> </ul>	<ul style="list-style-type: none"> <li>• Astonish</li> <li>• Hydrogen peroxide min. 30%</li> </ul>
	<ul style="list-style-type: none"> <li>• Candle wax</li> </ul>	<ul style="list-style-type: none"> <li>• Alcohol</li> <li>• Astonish</li> <li>• Mild alcohol-based cleaning agent</li> </ul>
	<ul style="list-style-type: none"> <li>• Adhesive tape marks</li> </ul>	<ul style="list-style-type: none"> <li>• Alcohol</li> </ul>
	<ul style="list-style-type: none"> <li>• Hard water</li> </ul>	<ul style="list-style-type: none"> <li>• Descaler</li> <li>• Vinegar</li> </ul>
	<ul style="list-style-type: none"> <li>• Soap stains</li> </ul>	<ul style="list-style-type: none"> <li>• Astonish</li> <li>• Hydrogen peroxide min. 30%</li> <li>• Mild alcohol-based cleaning agent</li> </ul>
	<ul style="list-style-type: none"> <li>• Scuffs (only for textured surfaces and Viento)</li> </ul>	Process the surface with an abrasive roller such as Scotch-Brite.
	<ul style="list-style-type: none"> <li>• Silicone</li> </ul>	<ul style="list-style-type: none"> <li>• Alcohol</li> <li>• Cleaning agent Interflon EM30 +</li> </ul>



**ARCHITYPE**  
more than stone



# 11. Environmental protection agreement

Protecting the environment is a top priority for Caesarstone. This means that our operations both internally and externally are conducted with environmental standards. From workplace safety to environmental compliance at all stages of production.

Therefore, our customers can be assured that by choosing our company's products, they are purchasing an environmentally friendly, non-toxic product that requires no additional maintenance.

We are constantly concerned about the safety and cleanliness of the environment.

Every Caesarstone employee shares our concern for the environment, making it a part of our daily lives.

The products of the Caesarstone company fully comply with international standards for hygienic and sanitary safety, ensuring the safe use of Caesarstone quartz stone worktops in the food service industry.



Caesarstone quartz surfaces meet the standards of ISO 14001, ISO 9001, and OHSAS 18001. Additionally, Caesarstone is a registered member of the USGBC (U.S. Green Building Council).



All Caesarstone quartz surfaces are certified according to the standards of the American Environmental Institute GREENGUARD (GEI). This certification confirms their compliance with the strictest standards regulating air pollution levels.



LEED (Leadership in Energy and Environmental Design) is a certification program developed by the U.S. Green Building Council (USGBC) as a standard for the design, construction, and operation of high-performance environmentally friendly buildings. The certification awarded to Caesarstone products by LEED is another example of our adherence to the most advanced environmental standards.



Caesarstone recycles 15-40% of first-grade quartz slabs rejected during the manufacturing process (reuse), as well as recycled glass and mirrors.



Caesarstone surfaces fully comply with kosher standards due to their low porosity..







**ARCHITYPE**  
more than stone



## 12. Technical characteristics

Test	Standard	Results
<b>PHYSICAL PROPERTIES</b>		
Water absorption	ASTM C97*	<0.05%
Density	ASTM C97*	2.2-2.4 g/cm <sup>3</sup>
	EN 14617-1*	2.2-2.4 g/cm <sup>3</sup>
Static bending tensile strength	ASTM C880	6,500-10,770 f/dm <sup>2</sup> ; 44.8-74.3 MPa
	EN 14617-2*	57.6 -70.0 MPa
Resistance to deformation	EN 14617-12*	Class A
Specific electrical resistance	EN 14617-13*	Volume resistance (Rv) = 0.92 x 10 <sup>14</sup> Ω
		Specific volume resistance (ρv) = 4.88 x 10 <sup>12</sup> Ωm
<b>DURABILITY</b>		
Impact resistance	ASTM D1709*	26.3lb (117N).
	EN 14617-9*	4,000 - 10,000 [J]
Compressive strength	ASTM C170*	21.312- 27.133 f/dm <sup>2</sup>
	EN 14617-15*	178.3-210.6 MPa
Wear resistance	ASTM C501 *	216-696
	ASTM C1243	Belt volume: V=132-244 mm <sup>3</sup>
	EN 14617-4*	Groove length = 21.8 mm or V=86 mm <sup>3</sup>
Resistance to temperature fluctuations	ASTM C1026*	No defects after 15 freezing and thawing cycles
	EN 14617-5*	No defects after 25 cycles of freezing and thawing
Hardness on the Mohs scale		6,5-7
<b>CHEMICAL AND STAIN RESISTANCE, CLEANING ABILITY</b>		
Stain resistance**	ANSI Z 124.6	Passed
Wearability and cleaning ability	ANSI Z 124.6	Passed
Chemical resistance	ANSI Z 124.6	Passed
	EN 14617-10*	Class C4



Test	Standard	Results
<b>THERMAL PROPERTIES</b>		
Linear thermal expansion	ASTM D696	-30 to +30°C: 1.3-1.9 x 10 <sup>-5</sup> cm/cm/°C
	EN 14617-11*	-30 to +30°C: 2.1 x 10 <sup>-5</sup> (°C <sup>-1</sup> ); -30 to +60°C: 2.7 x 10 <sup>-5</sup> (°C <sup>-1</sup> )
Thermal conductivity	EN 12664/ISO 8301*	1.75 W/m. °K (average T 10°C)
Thermal shock	EN 14617-6*	No visual defects after 10 cycles; mass loss = 0.02% -0.05%; loss of flexural strength = 0.7% -1.1%
Resistance to boiling water	NEMA LD3-3.5	Passed
Resistance to high temperatures	NEMA LD3-3.6	Passed
<b>SAFETY</b>		
Smouldering cigarette resistance tests	ANSI Z 124.6	Passed
Open burning	ASTM E84*	Class 1 and Class A
Classification by fire safety	EN 13501-1*	Wall panelling: B-s1-d0; floors and stairs: B-fl-s1
Static coefficient of friction	ASTM C1028*	On receipt - dry: 0.8; wet: 0.6
		At renewal - dry: 0.9; wet: 0.6
Slip resistance	DIN 51130*	"Inclined oiled surface" test - Cat. R9-10
	DIN 51097*	«Inclined surface, wet bare feet» test - cat. C
	EN 14231*	Wet condition: 13-21 SRV Dry condition: 43-53 SRV
	AS/NZS 4586*	"4-S" pendulum test: 25-30 BPN
		«Inclined surface, wet bare feet» test - cat. B
	"Inclined surface, wet bare feet» test - Cat. R10	
Radioactivity	ANSI/N42.14	<sup>226</sup> Ra = 1.4-6.8; <sup>232</sup> Th = 1.4-3.7; 40K = <3-30.3 (Bq/kg dry weight)

\* The results represent a partial range of the series.

\*\* Some models require cleaning to remove certain stains.



 caesarstone®



**ARCHITYPE**  
more than stone

05-555 Tarczyn, al. Krakowska 64,  
Grzędy

+48 22 602 20 22

[info@architype.eu](mailto:info@architype.eu), [architype.eu](http://architype.eu)